



2024 Product Catalog



Shown Here
n00k™ Drawer





Shown Here
The Crystal Series

Table of Contents



GROMMETS04



WIRE MANAGEMENT08



TABLE CONNECTORS & ACCESSORIES..... 18



HEIGHT ADJUSTABLE TABLES & MECHANISMS28



BELOW THE DESK STORAGE..... 32



ABOVE THE DESK STORAGE.....40



GLOSSARY OF PRODUCTS48



ORDERING INFORMATION49



Innovation

The Custom Accents® grommet collection is designed to help facilitate the flow of wires and cords around the desktop and work areas. Streamline the desk or work station with this extensive selection of grommets. Telephone wires, computer and keyboard cables, desk lighting cords, laptop wires, cell phone / tablet cables, and video component cables are easily managed and controlled. By eliminating wire clutter, office and home environments become neater, safer, and more efficient.

Shown Here
Flexigrom®

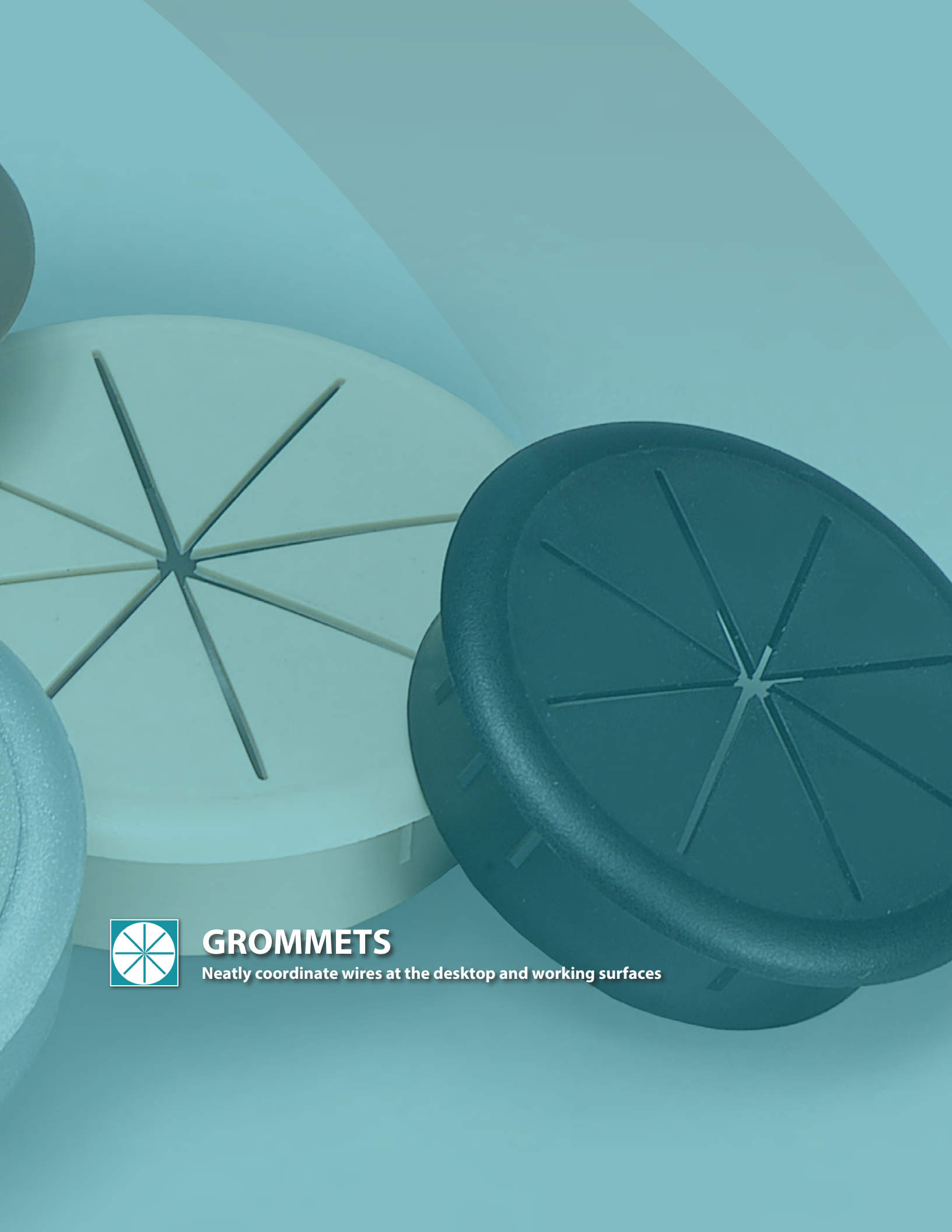

GROMMETS

Neatly coordinate wires at the desktop and working surfaces



GROMMETS

Neatly coordinate wires at the desktop and working surfaces



WIRE GROMMET



This unique three-piece wire grommet allows for adjustable hole openings. The wire grommet is offered in three different sizes and several different color options. Ideal for workspaces with computers and various electronics, this grommet can easily handle multiple data, power, and peripheral cables, as well as phone, fax, and coaxial lines. The 50mm Wire Grommet is ideal for smaller spaces with a single computer, whereas the 60mm and 80mm Wire Grommet is ideal for multiple computers and electronics. The adjustable top allows cables to be fed through from any direction while the size of the opening can be adjusted to free up more space or tighten to secure the cables.

Custom colors are available upon request.

50MM WIRE GROMMET

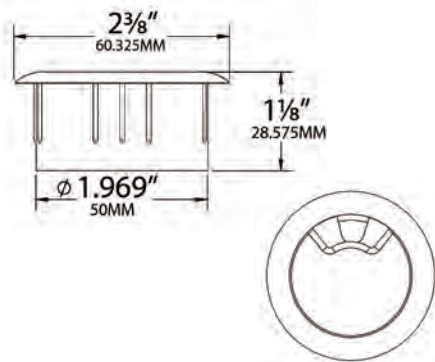

PARTS / CARTON	PART NO.	COLOR
100	CPF-2500	BLACK
100	CPF-2501	WHITE
100	CPF-2502	BROWN
100	CPF-2503	GRAY
100	CPF-2504	ALMOND
100	CPF-2506	BEIGE
100	CPF-2507	BATTLESHIP GRAY
100	CPF-2512	STUDIO GRAY

60MM WIRE GROMMET

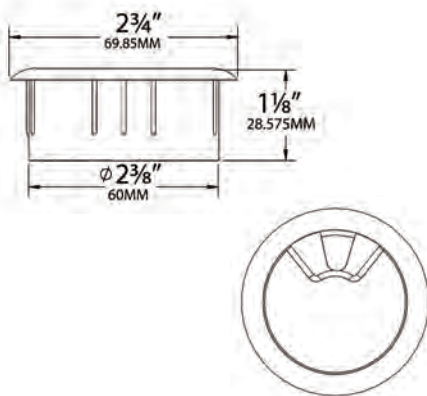

PARTS / CARTON	PART NO.	COLOR
100	CPF-2600	BLACK
100	CPF-2601	WHITE
100	CPF-2602	BROWN
100	CPF-2603	GRAY
100	CPF-2604	ALMOND
100	CPF-2606	BEIGE
100	CPF-2607	BATTLESHIP GRAY
100	CPF-2610	SLATE GRAY
100	CPF-2612	STUDIO GRAY
100	CPF-2617	LIGHT SLATE
100	CPF-2623	SILVER

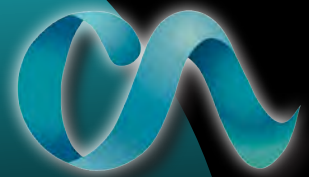

PARTS / CARTON	PART NO.	COLOR
100	CPF-2800	BLACK
100	CPF-2801	WHITE
100	CPF-2802	BROWN
100	CPF-2803	GRAY
100	CPF-2804	ALMOND
100	CPF-2806	BEIGE
100	CPF-2807	BATTLESHIP GRAY
100	CPF-2810	SLATE GRAY
100	CPF-2812	STUDIO GRAY
100	CPF-2823	SILVER

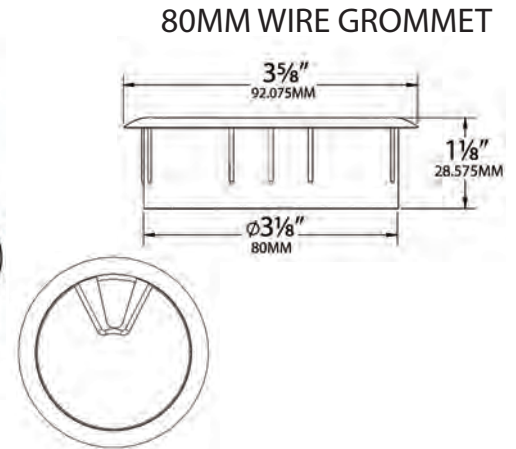
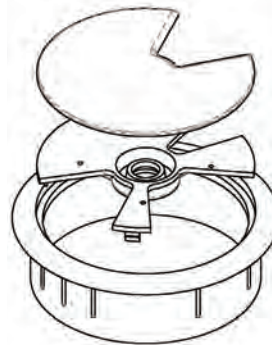

FLEXIGROM® WIRE GROMMET

The Flexigrom® Wire Grommet features a flexible top that allows multiple wires to be fed from any direction. This grommet also features a one-piece construction that eliminates lost covers or pieces. The soft top is safe for all wires and cables that are fed through the grommet, and will easily allow movement through the grommet without causing damage, while providing a firm grip that will prevent the wires and cables from falling down when not in use.



Custom colors are available upon request.

Patent Number: D443, 811

PARTS / CARTON	PART NO.	COLOR
100	CPF-2670	BLACK
100	CPF-2671	WHITE
100	CPF-2672	BROWN
100	CPF-2673	GRAY
100	CPF-2674	ALMOND
100	CPF-2676	BEIGE
100	CPF-2677	SILVER METALLIC

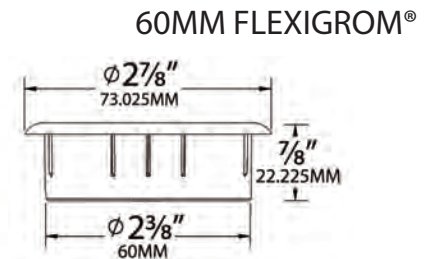
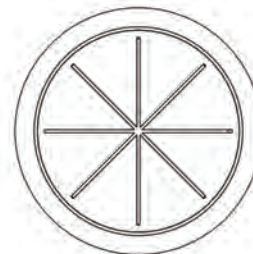

PARTS / CARTON	PART NO.	COLOR
100	CPF-2870	BLACK
100	CPF-2871	WHITE
100	CPF-2872	BROWN
100	CPF-2873	GRAY
100	CPF-2876	BEIGE
100	CPF-2877	SILVER METALLIC

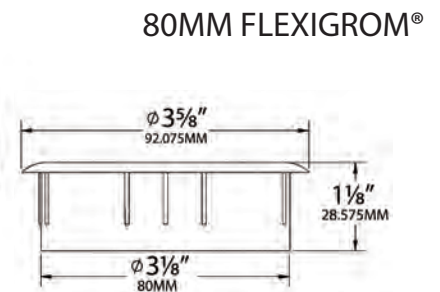
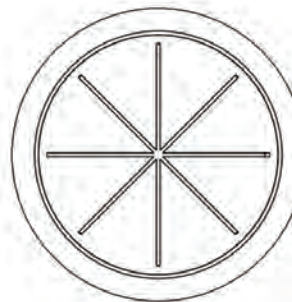



GROMMETS

Neatly coordinate wires at the desktop and working surfaces



OVAL GROMMET

Excellent for multiple work centers, the Oval Grommet is designed with the same unique three-piece top as the wire grommet and allows for adjustable openings.

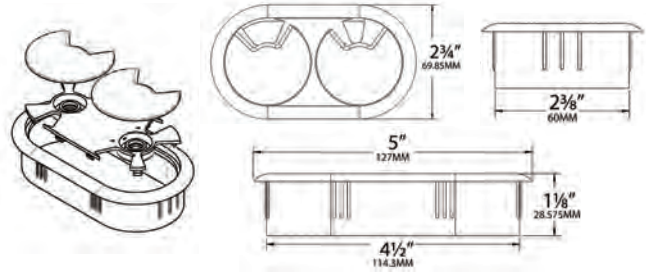

DESCRIPTION	PARTS / CARTON	PART NO.	COLOR
OVAL GROMMET	100	CPF-2900	BLACK

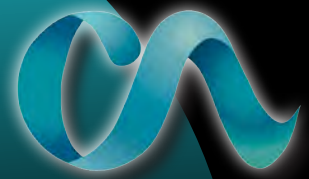

PAPER SLOT GROMMET



Paper Slot Grommets are designed to be used in either commercial or consumer sized tractor-feed computer printer stands. These grommets have a slightly outward bow, which assists in keeping grommets in place after installation.

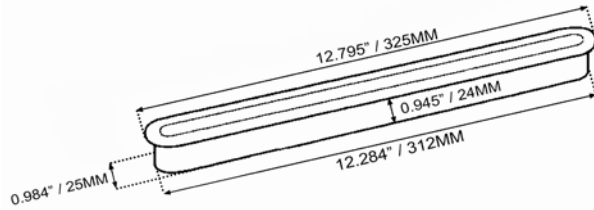
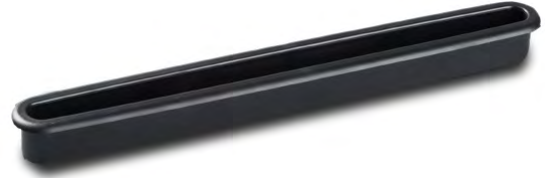

DESCRIPTION	PARTS / CARTON	PART NO.	COLOR
PAPER SLOT GROMMET	100	CPF-21500	BLACK
LARGE PAPER SLOT GROMMET	100	CPF-21750	BLACK

Design



Managing wires is a necessity. Yet, it does not have to be at the cost of design. The Custom Accents® offerings of wire management products are attractive and functional. The epitome of form following function, these hip, sleek wire managers provide different ways to contain wires in unique styles.

Shown Here

Link 360™



WIRE MANAGEMENT

Organize and control wires from the floor to the work surface



WIRE MANAGEMENT

Organize and control wires from the floor to the work surface



LINK 360™



Link 360™ Cable Manager Kits are offered complete with 50 Link 360™ elements, 1 Top Connector, 1 Quad Connector, 1 Dumbbell Connector, and 1 Foot Assembly. The Kits can be used for height-adjustable mechanisms up to 51", and for free-standing use. Special kits are available upon request.

DESCRIPTION	PARTS / CAR-TON	PART NO.	COLOR
LINK 360™ CABLE MANAGER KIT, 1300MM, 51.181"	1	CPF-75361	BLACK
LINK 360™ CABLE MANAGER KIT, 1300MM, 51.181"	1	CPF-75362	WHITE
LINK 360™ CABLE MANAGER KIT, 1300MM, 51.181"	1	CPF-75363	SILVER
LINK 360™ CABLE MANAGER KIT, 1300MM, 51.181"	1	CPF-75364	TRANSLUCENT
LINK 360™ CABLE MANAGER KIT, 1300MM, 51.181" WITH 2 MAGNETIC POCKETS	1	CPF-75361M	BLACK
LINK 360™ CABLE MANAGER KIT, 1300MM, 51.181" WITH 2 MAGNETIC POCKETS	1	CPF-75362M	WHITE
LINK 360™ CABLE MANAGER KIT, 1300MM, 51.181" WITH 2 MAGNETIC POCKETS	1	CPF-75363M	SILVER
LINK 360™ CABLE MANAGER KIT, 1300MM, 51.181" WITH 2 MAGNETIC POCKETS	1	CPF-75364M	TRANSLUCENT



Magnetic Pocket Side Connector



Magnetic Pocket Top Connector

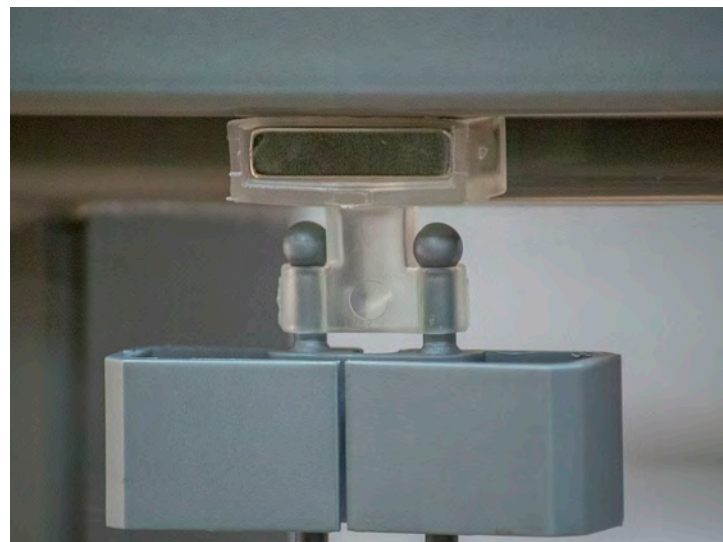

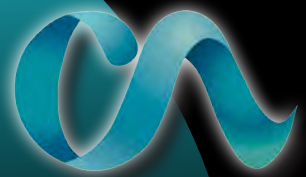

The patented Link 360™ is a new multi-directional cable manager that is used for height-adjustable mechanisms. Simply add Link 360™ elements to achieve the desired height. Wires and cables are fed from the work surface down through the elements to the weighted foot at the bottom. The Link 360™ is flexible and can be attached to the leg of the table base by use of the Link 360™ magnetic pockets or tape, or it can be free-standing.

360™ LINK

4 colors &
360 degrees of flexibility



3 different positions

The Link 360™ Elements can be individually snapped in place into three positions: Most flexible, less flexible, and most rigid. The rigid position is best for use as a horizontal wire manager.

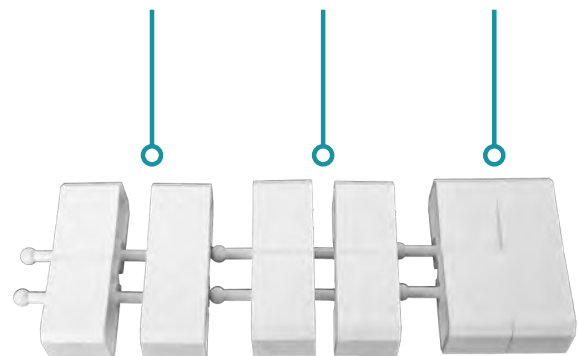



WIRE MANAGEMENT

Organize and control wires from the floor to the work surface



CABLE SNAKE



The Cable Snake is a unique wire manager for controlling wires from the work surface to the floor. All wires are completely hidden and protected inside the Cable Snake; the wires are then fed out through the bottom at the foot enabling the user to plug them into a socket. It is highly flexible and can be used on stationary or height-adjustable desks and comes with the top mounting plate and foot.

The Cable Snake can also be purchased a la carte, enabling you to configure it how you would like.

It can be used with or without the Cable Trough (sold separately).

DESCRIPTION	PARTS / CARTON	PART NO.	COLOR
CABLE SNAKE, 720MM, 28.346"	16	CPF-46055A10	BLACK
CABLE SNAKE, 720MM, 28.346"	16	CPF-46055AB1	SILVER
CABLE SNAKE, 1300MM, 51.181"	12	CPF-46055B10	BLACK
CABLE SNAKE, 1300MM, 51.181"	12	CPF-46055BB1	SILVER
CABLE SNAKE TOP MOUNTING PLATE	12	CPF-46056A10	BLACK
CABLE SNAKE TOP MOUNTING PLATE	12	CPF-46056AB1	SILVER
CABLE SNAKE SINGLE ELEMENT	100	CPF-46056B10	BLACK
CABLE SNAKE SINGLE ELEMENT	100	CPF-46056BB1	SILVER
CABLE SNAKE FOOT	12	CPF-46056C10	BLACK
CABLE SNAKE FOOT	12	CPF-46056CB1	SILVER



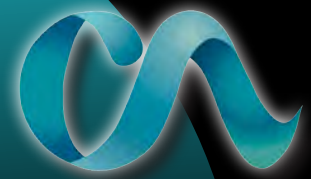

CABLE TROUGH 

The Cable Trough is an injection molded wiring duct made from high-impact glass-filled nylon and designed to be snapped together to create any length channel you need in 8" increments. It is also designed to be easily installed underneath a work surface by means of the Fold Fastening Set or to a vertical panel with the Wall Mounting Bracket. The Fold Fastening system allows the Cable Trough to be tilted in either direction so that you can easily access the cabling when necessary. Enclose the channel with the Cable Trough End Cap and guide the wires down to the floor using the snap-in Cable Snake (sold separately). The Cable Clamp can snap into the hole in the Trough for help in managing and securing the cables.



Special kit packaging available upon request.

PIC-TURE	DESCRIPTION	PARTS / CARTON	PART NO.	COLOR
1.A	CABLE TROUGH, 6" WIDE X 8" LENGTH	60	CPF-46052C10	BLACK
1.A	CABLE TROUGH, 6" WIDE X 8" LENGTH	60	CPF-46052CB1	SILVER
1.B	CABLE TROUGH WALL MOUNT BRACKET	50	CPF-46052D10	BLACK
1.B	CABLE TROUGH WALL MOUNT BRACKET	50	CPF-46052DB1	SILVER
1.C	CABLE TROUGH FOLD FASTENING SET	50	CPF-46053A10	BLACK
1.C	CABLE TROUGH FOLD FASTENING SET	50	CPF-46053AB1	SILVER
1.D	CABLE TROUGH END CAP	25	CPF-46056D10	BLACK
1.D	CABLE TROUGH END CAP	25	CPF-46056DB1	SILVER
1.E	CABLE TROUGH CABLE CLAMP	25	CPF-46053D10	BLACK
	CABLE TROUGH LINK 360 CONNECTOR		CPF-78001	BLACK
	CABLE TROUGH LINK 360 CONNECTOR		CPF-78003	SILVER

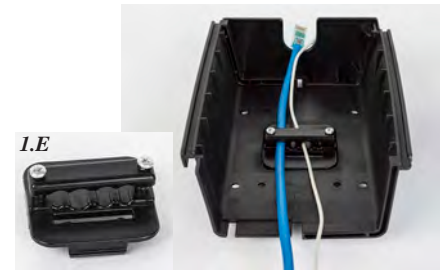



WIRE MANAGEMENT

Organize and control wires from the floor to the work surface



LATCH DUCT AND WIREMASTER CHANNELS

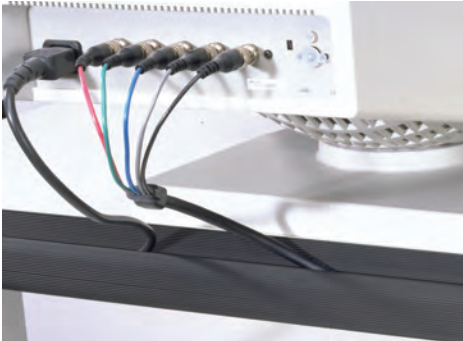

Easily organize wires and cables with these expertly designed cable channels. Extruded from the highest quality plastics, the Custom Accents® cable channels feature a simple design that provides wire management functionality to any work station. Each channel is available with double-sided 3M™ tape for easy installation and can be cut to size on-site to fit any desk length.

LATCH DUCT CHANNEL

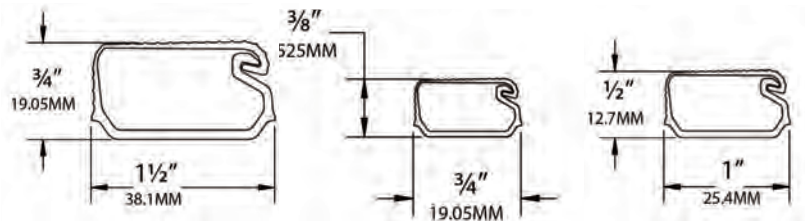

Features a living hinge that encloses the wires and snaps shut. Users can easily add and remove cables as their wire management needs change over time.

DESCRIPTION	PARTS / CARTON	PART NO.	COLOR
1 1/2" LATCH DUCT CHANNEL, 2.5 METERS	40	CPF-3100	BLACK
3/4" LATCH DUCT CHANNEL, 2.5 METERS	100	CPF-3300	BLACK
1" LATCH DUCT CHANNEL, 2.5 METERS	84	CPF-3500	BLACK

LATCH DUCT CLIP

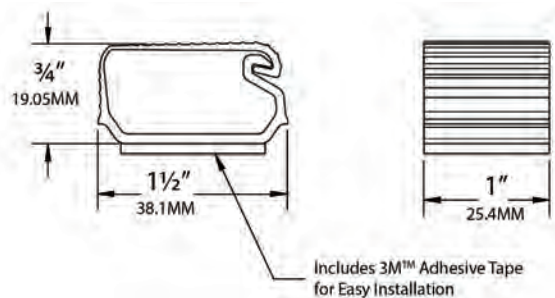

Allows use of smaller lengths in different configurations to keep wires hidden.

DESCRIPTION	PARTS / CARTON	PART NO.	COLOR
1 1/2" X 1" LATCH DUCT CLIP	1000	CPF-3110	BLACK

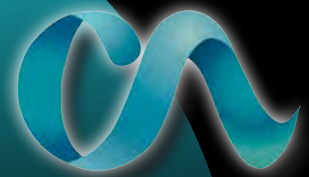

WIREMASTER J CHANNEL

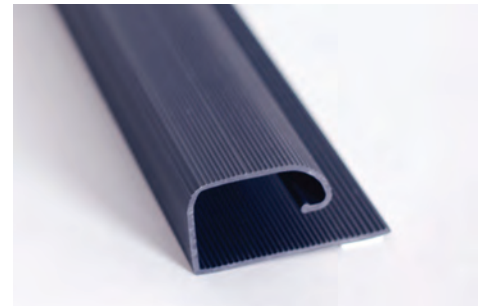
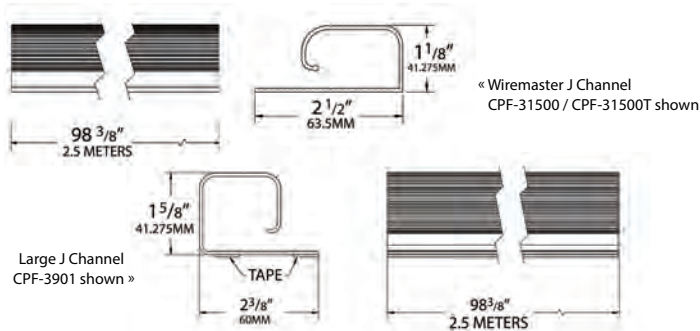

The Wiremaster channel sets the industry standard for simple, yet highly effective wire management hardware. Wires can easily be added and removed by the user. Upgrade to the Large size for additional wire capacity.

DESCRIPTION	PARTS / CARTON	PART NO.	COLOR
WIREMASTER J CHANNEL, 2.5M, W/TAPE	36	CPF-31500T	BLACK
WIREMASTER J CHANNEL, 2.5M, NO TAPE	36	CPF-31500	BLACK
LARGE J CHANNEL, 2.5M, W/TAPE	24	CPF-3901	BLACK

MINI WIREMASTER CHANNEL

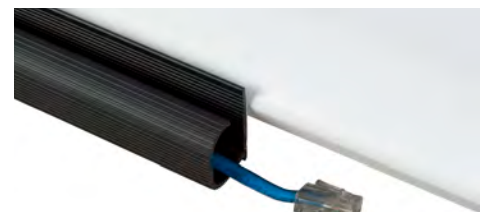
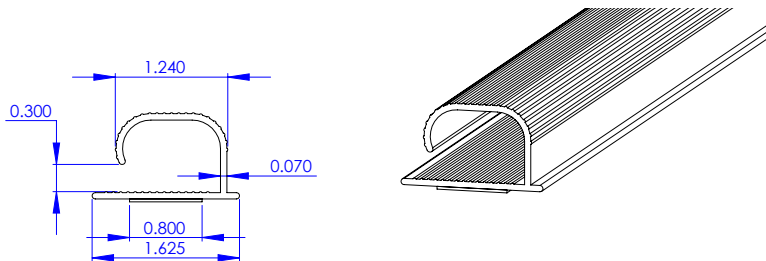

A smaller, less visual version of the Wiremaster Channel.

DESCRIPTION	PARTS / CARTON	PART NO.	COLOR
MINI WIREMASTER CHANNEL, 2.5M, W/TAPE	60	CPF-31400T	BLACK

WIREWAY CHANNEL

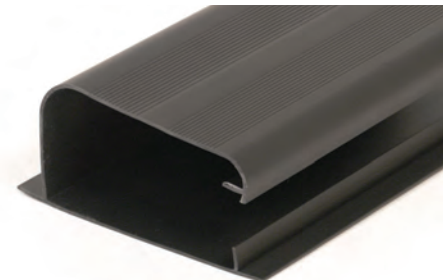
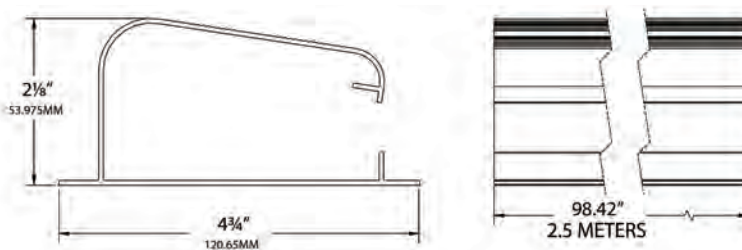

A modified version of the Wiremaster Channel, the Wireway Channel features an angled hinge to create additional storage space without increasing the product's footprint.

DESCRIPTION	PARTS / CARTON	PART NO.	COLOR
WIREWAY CHANNEL, 2.5M, NO TAPE	16	CPF-3990	BLACK



WIRE MANAGEMENT

Organize and control wires from the floor to the work surface



WAVE CABLE GRIP

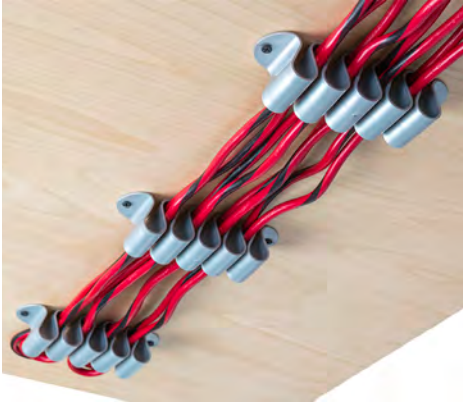

Designed and manufactured by Custom Accents®, the Wave Cable Grip features an intelligent design that allows cables, wires, and other items to slip into the unit and stay in place without the use of any accessories or adhesives. Place these grips anywhere you need to get cables under control, such as underneath the work surface, sides of work stations, walls, or even on top of a desk. Simple to install with only two screws, users can easily move the Wave Cable Grip to different positions as their work environment changes. Easily slip cables into the fingers of the Wave and they will be held confidently in place wherever the Wave is mounted. Ride the Wave!

DESCRIPTION	PARTS / CARTON	PART NO.	COLOR
WAVE CABLE GRIP 146MM x 45MM (5.75" x 1.75")	100	CPF-3450B	BLACK
	100	CPF-3453S	SILVER

WAVE CABLE GRIP

146MM x 45MM (5.75" x 1.75")

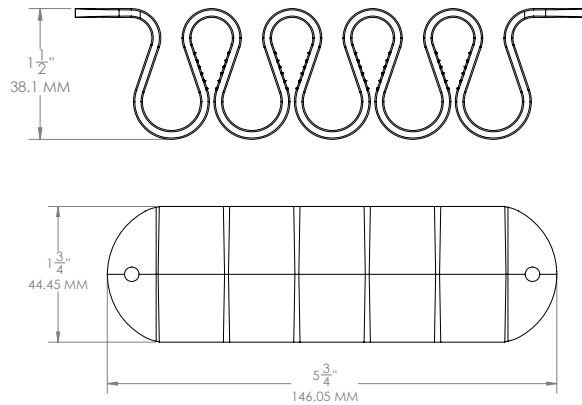

The Wave features lined grooves that help grip the cables to keep them firmly in place, no matter where it is positioned.

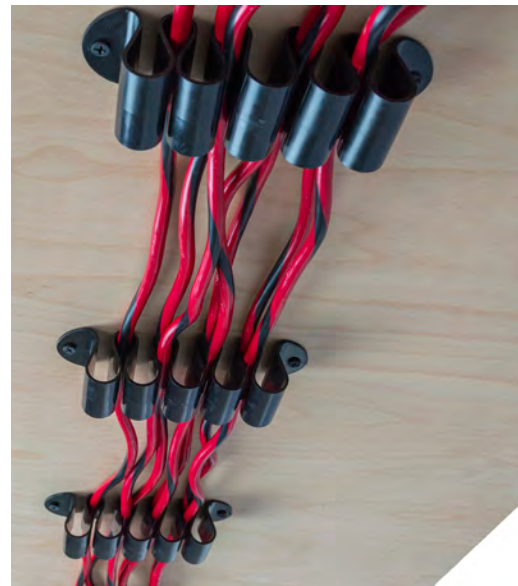

Control and Elegance
Flexibility Where You Need It

The Link 360™ by Custom Accents®

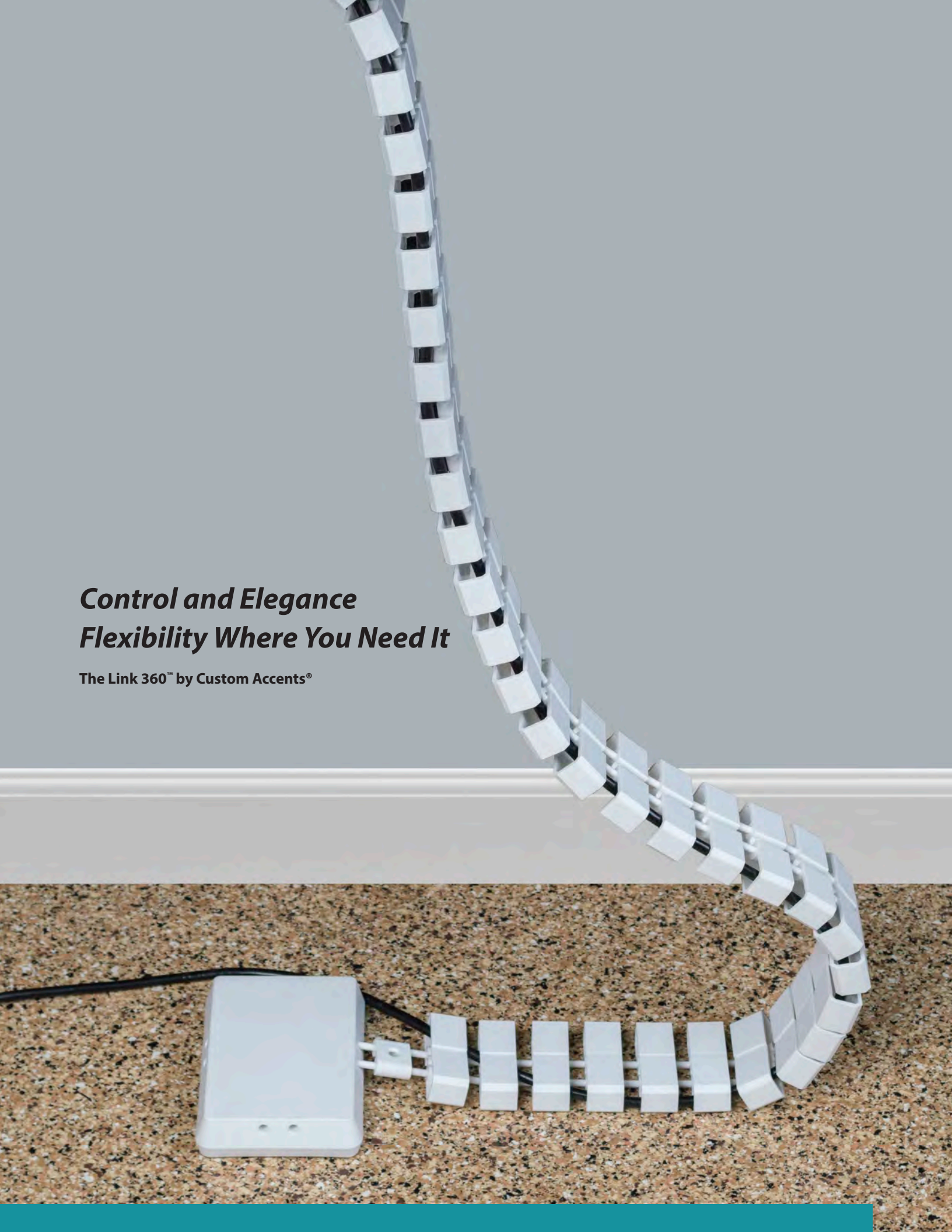



Setting New Standards

Custom Accents® introduces a product line from Plako®, a premier European furniture accessory manufacturer. Now providing an innovative table connector and accessory line, Custom Accents® continues to be at the forefront of the furniture design industry. All of the products being offered are manufactured using the highest quality materials and designed with functionality and style in mind.

Shown Here

Table Connectors Type "Lock"



TABLE CONNECTORS & ACCESSORIES

Intelligent and space-saving innovations for modern desk systems



TABLE CONNECTORS & ACCESSORIES

Intelligent and space-saving innovations for modern desk systems



TABLE CONNECTORS



Easily connect and disconnect tables and desks for simple room configurations.

Quick to install and built to last, these Table Connectors will provide clients with durability and functionality for years to come.

- Easily connect multiple desks or tables of any shape
- Seamless assembly and handling
- Ability to support a top without the use of legs
- Steel and plastic construction
- Low profile design
- High-load capacity
- No "male" or "female" parts

TABLE CONNECTOR TYPE "LOCK"



DESCRIPTION	PARTS / CARTON	PART NO.	COLOR
TABLE CONNECTOR TYPE "LOCK" 1 HALF-PART, RAL 9005	100	CPF-47900A10	BLACK
SCREW SPAX-S, PANHEAD 4X30MM (0.16" X 0.18")		CPF-Z4790101	

TABLE CONNECTOR TYPE "DIVIDE"

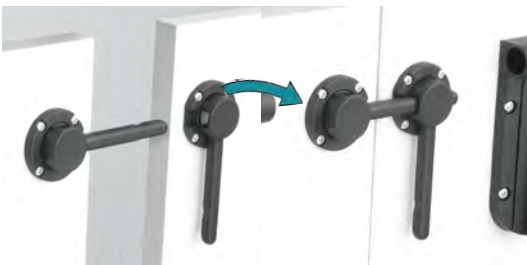

DESCRIPTION	PARTS / CARTON	PART NO.	COLOR
TABLE CONNECTOR TYPE "DIVIDE" 1 HALF-PART, RAL 9005	100	CPF-47905A10	BLACK
SCREW SPAX-S, PANHEAD 4X20MM (0.16" X 0.79")		CPF-Z4790501	

TABLE CONNECTOR TYPE "STEEL"

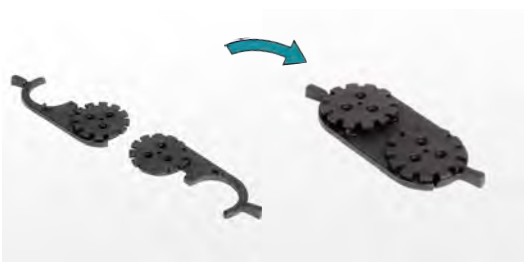

DESCRIPTION	PARTS / CARTON	PART NO.	COLOR
TABLE CONNECTOR TYPE "STEEL" 1 HALF-PART, RAL 9005	100	CPF-47901A10	BLACK
SCREW SPAX-S, PANHEAD 4.5X25MM (0.18" X 0.99")		CPF-Z4820101	

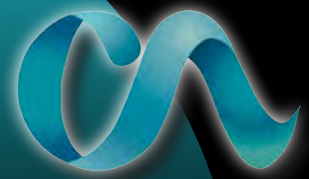

PERFORMANCE CONNECTOR

Designed to support table tops without legs.
A pair will support 200lbs of downforce.

DESCRIPTION	PARTS / CARTON	PART NO.	COLOR
MODULE CONNECTOR TYPE "LOCK" 120MM (4.73") (1 FIXING PLATE + 1 HOOK), RAL 9005	80	CPF-47920A10	BLACK



MODULE CONNECTORS 

With just a twist or a "click", simply connect modular furniture in any configuration to form rows, groups, or unique seating formations.

Ideal for any communal seating area in residential, commercial, or educational settings.



Universal connectors for upholstery, modules, and more

- Manufactured using high-quality nylon with no metallic or sharp edges
- Greatly reduces damage to upholstery and base unit
- Single component items - no separate male or female parts

Easily connected or disconnected by using integral handle. 360 degrees of connectivity.

DESCRIPTION	PARTS / CARTON	PART NO.	COLOR
MODULE CONNECTOR TYPE "LOCK" 120MM (4.73") (1 FIXING PLATE + 1 HOOK), RAL 9005	80	CPF-47920A10	BLACK
MODULE CONNECTOR TYPE "LOCK" 140MM (5.52") (1 FIXING PLATE + 1 HOOK), RAL 9005	80	CPF-47920B10	BLACK

SV-LOCK



Ratcheted at 5mm (0.2") increments.

Easily connected or disconnected by pushing or pulling components together or apart.

360 degrees of connectivity.

DESCRIPTION	PARTS / CARTON	PART NO.	COLOR
MODULE CONNECTOR TYPE "DIVIDE" 120MM (4.73") (1 FIXING PLATE + 1 HOOK), RAL 9005	80	CPF-47921A10	BLACK

SV-DIVIDE

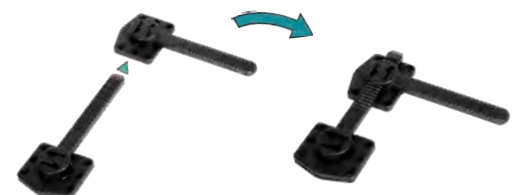



TABLE CONNECTORS & ACCESSORIES

Intelligent and space-saving innovations for modern desk systems



SYSTEM PANEL

The perfect removable modesty panel holder that also works with folding tables.

Neutral design.

Makes transport and service easier.

Easy assembly and disassembly with only one "click".

For wood, perforated plate, glass, and fabric.

SYSTEM PANEL FIX



SYSTEM PANEL FLEX



PICTURE	DESCRIPTION	PARTS / CARTON	PART NO.	COLOR
3.A	SYSTEM PANEL FIX, RAL 9005	80	CPF-48200A10	BLACK
3.B	SYSTEM PANEL FLEX, RAL 9005	80	CPF-48200B10	BLACK
3.C	SYSTEM PANEL SPACER, RAL 9005, H = 40MM (1.58")	80	CPF-48201A10	BLACK
	SCREW SPAX-S, PANHEAD 4.5 X 25MM (0.17" X 0.99")	80	CPF-Z4820101	

The Custom Accents® Online Store



Direct from our warehouse to your doorstep.

No minimum purchase price.
No minimum purchase quantity.

store.customaccents.com



TABLE CONNECTORS & ACCESSORIES

Intelligent and space-saving innovations for modern desk systems



TIP TOP FOLDING TABLE SYSTEM FULL KIT PACKAGES

The Tip Top System is an intelligent, space-saving folding desk and table system with an elegant design.

Ideal for conference areas, training areas, and desks.

The full kit includes all necessary components except for the table top.



5.A



5.A



5.A

PICTURE	DESCRIPTION	PARTS / CARTON	PART NO.	COLOR
5.A	TIP TOP STANDARD KIT, 1400MM (55.12")	1	CPF-47631A99	SILVER LEGS
5.A	TIP TOP STANDARD KIT, 1600MM (63")	1	CPF-47632A99	SILVER LEGS
5.A	TIP TOP STANDARD KIT, 1800MM (70.87")	1	CPF-47633A99	SILVER LEGS

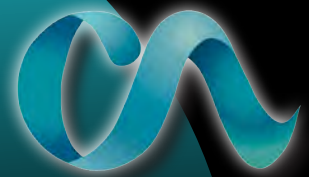

FIS 214 FOLDING TABLE ADAPTER

The FIS 214 Folding Table Adapter is a universal mechanism for tip-top tables up to 100" x 40". It features a built-in release mechanism and table connector. The FIS 214 offers 25% more stability than other mechanisms.

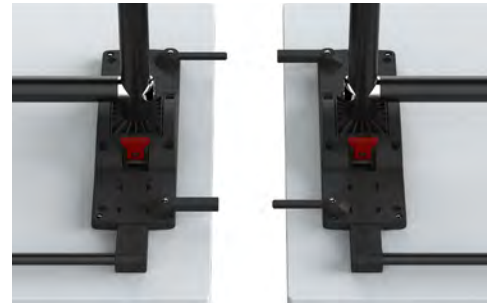

DESCRIPTION	PARTS / CARTON	PART NO.	COLOR
FIS 214 FOLDING TABLE ADAPTER, UNIVERSAL	12	CPF-47545A10	BLACK
FIS 214 DIVIDE TYPE TABLE CONNECTOR SET	12	CPF-47546A10	BLACK
FIS 214 RELEASE MECHANISM	12	CPF-47547A10	BLACK

BAG HOLDER ATTACHMENT

Keep your personal items organized with the Bag Holder Attachment. It is the ideal solution for both indoor and outdoor tables. This piece can be easily mounted to a rounded or square table leg to keep purses, bags, jackets, or any other accessories above the floor and hidden out of sight.

DESCRIPTION	PARTS / CARTON	PART NO.	COLOR
HANDBAG HOOK, 60MM TUBE	10	CPF-47565A10	BLACK
HANDBAG HOOK, 76MM TUBE	10	CPF-47565B10	BLACK
HANDBAG HOOK, 80MM X 80MM	10	CPF-47565C10	BLACK





TABLE CONNECTORS & ACCESSORIES

Intelligent and space-saving innovations for modern desk systems

SYSTEM TAKE OFF

SYSTEM TAKE OFF ADAPTER



Suitable for all tabletop shapes.

Freely positional.

Low staking height with integrated protection buffer.

Will accept table legs up to 60mm (2.362”).



SYSTEM SL FOLDING LEG ADAPTER

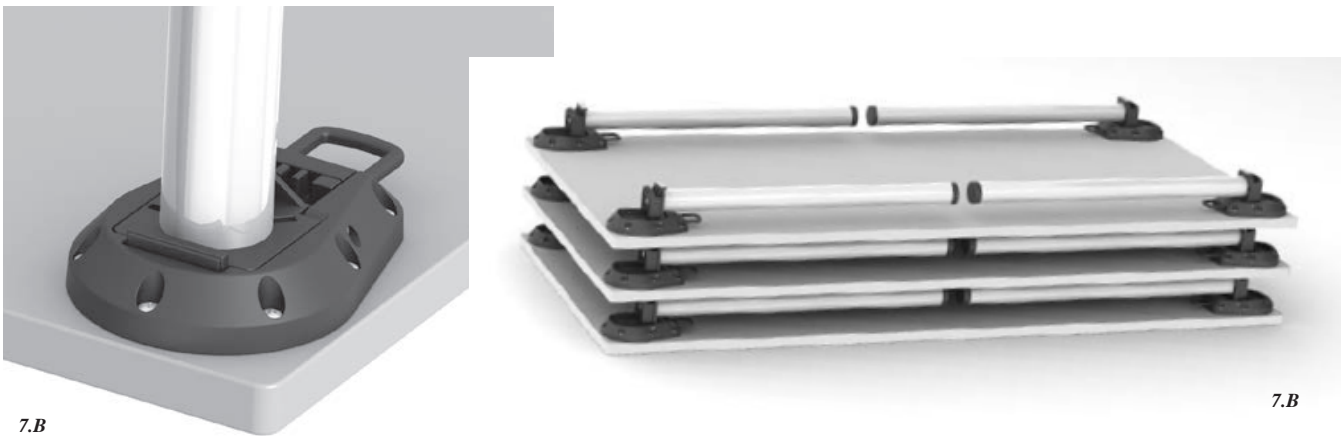

The System SL Folding Leg Adapter is designed to quickly and effortlessly allow users to fold table legs for easy storage. Adding this accessory to tables also allows for added functionality when moving multiple tables from one area to another.

Will accept table legs up to 60mm (2.362”).

PICTURE	DESCRIPTION	PARTS / CARTON	PART NO.	COLOR
7.A	SYSTEM TAKE OFF ADAPTER	1	CPF-46250A10	BLACK
7.B	SYSTEM SL FOLDING LEG ADAPTER	1	CPF-47541A10	BLACK

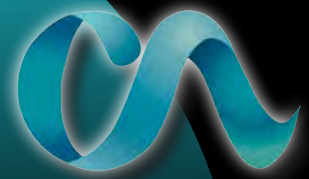

TIP TOP FOLDING TABLE SYSTEM ADAPTER PIECES



FOLDING LEG MECHANISMS

These heavy duty adapters allow you to take a standard round or square table leg and make it a folding leg.



6.A

FIS 409 Table Adapter

Adapter for linking table leg and table top. The simple and robust release mechanism enables easy handling and a secure connection.

RELEASE KIT FOR TIP TOP TABLES



6.C

Designed to quickly and effortlessly release the table top when used with the Tip Top Table System.

Legs, castors, and release bar not included.

PICTURE	DESCRIPTION	PARTS / CARTON	PART NO.	COLOR
6.A	TABLE ADAPTER FIS 409 DIA 50MM (1.97") - USED WITH 50MM (2.00") ROUND	12	CPF-47530A10	BLACK, RED LEVEL
6.A	TABLE ADAPTER FIS 409 DIA 70MM (2.75") - USED WITH 70MM (2.75") TO 76MM (3.00") ROUND OR 2.00" SQUARE LEGS	12	CPF-47530C10	BLACK, RED LEVEL
	RING FOR 76MM (3.00") LEGS ON CPF-47530C10	12	CPF-47533A10	BLACK
6.C	TIP TOP RELEASE 710 - 1 PAIR COMPLETE, 2 X RELEASE MECHANISM COMPLETE, 4 X SPAX-S PANHEAD 4.5X35 (0.18"X1.38"). FOR USE WITH FIS 409	12	CPF-48792A99	BLACK
	FIS 409 WEDGE (ANTI-TWIST DEVICE) FOR 2.00" SQUARE LEGS	12	CPF-47532A99	BLACK
	FOOT CLAMP - NECESSARY FOR UPRIGHT SECURED POSITION		CPF-47531A99	BLACK



Versatile

Reducing ergonomic stressors is important to office workers sitting or standing for long periods of time. Utilizing height adjustable tables to enable users to stand during work hours not only improves health and mood but also allows ergonomic adjustments and freedom that normal fixed workstations would not.

Shown Here

Height Adjustable Lounge Table



HEIGHT ADJUSTABLE MECHANISMS

Organization products designed to create smarter work environments



HEIGHT ADJUSTABLE MECHANISMS

Organization products designed to create smarter work environments



HEIGHT ADJUSTABLE LOUNGE TABLE



The Lounge Table can be adjusted to the ideal height and angle for your space. You can choose to sit or stand with the table or smoothly adjust the height to do both. Extending to a maximum height of 40" makes this table an excellent piece for meeting rooms, lobbies, classrooms or homes.

The Lounge Table HV comes complete as a kit except for the top.



DESCRIPTION	PARTS / CARTON	PART NO.	COLOR
LOUNGE TABLE MECHANISM	12	CPF-47553A10	BLACK
	12	CPF-47553A30	WHITE
LOUNGE TABLE HV, HEIGHT ADJ. 630MM-1030MM	1	CPF-48096B10	BLACK
	1	CPF-48096B30	WHITE

CALL US TODAY AT 847-640-4725

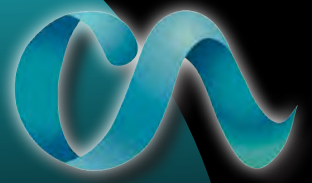



Convenient

Keeping keyboards, office supplies, and files within reach is a requirement for an efficient, comfortable work space. The Custom Accents® storage options for below the desk include keyboard trays, pencil drawers, a laptop storage holder, and a panel for added seated privacy.

Shown Here
Universal Drawer Storage Tray



BELOW THE DESK STORAGE

Organization products designed to create smarter work environments



BELOW THE DESK STORAGE

Organization products designed to create smarter work environments

PENCIL AND NOTEBOOK DRAWERS

The n00k™ is a drawer with ball bearing slides designed to fit underneath work surfaces, especially height adjustable tables. The n00k™ is smaller in size, only 8" in depth, and features a tray that can slide across the drawer and can also be removed and placed on the work surface to hold accessories or personal items. The tray also allows for easy access storage inside the drawer so items can be quickly reached. There is also a spot on the n00k™ drawer to easily place pens and pencils to be within reach.

n00k™ DRAWER

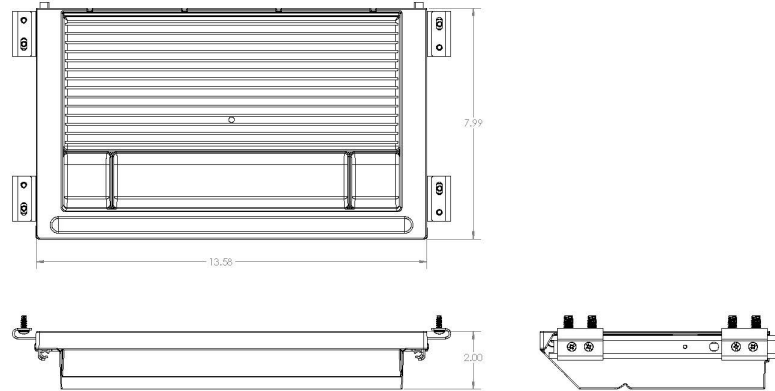

There are several small wire management slots on the back of the n00k™ to allow the user to place items such as their mobile phone inside and then draw the charging cord out the back to be plugged in for charging use.

DESCRIPTION	PARTS / CARTON	PART NO.	COLOR
	10	CPF-89320	BLACK
8" n00k™ DRAWER WITH BALL BEARING SLIDES	10	CPF-89322	WHITE
	10	CPF-89323	SILVER

PENCIL TRAY

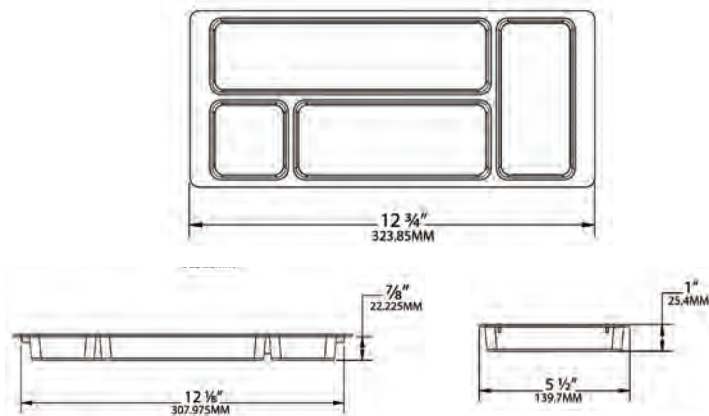

A perfect little organization accessory for the home or office environment, the Pencil Tray is designed to sit on top of most desk drawers and provides additional storage for items such as paper clips, pens, pencils, etc.

DESCRIPTION	PARTS / CARTON	PART NO.	COLOR
PENCIL TRAY	100	CPF-F815P	BLACK

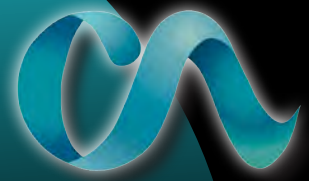

UNIVERSAL DRAWER STORAGE TRAY

The Universal Drawer Storage Tray is a unique design manufactured by us in-house. It is designed for installation anywhere inside a drawer using a wide bracket with two screws, so it does not have to capture one corner for installation. It features a modern curved design with a pencil slot and compartment for various accessories or items. This inexpensive yet universal drawer storage tray offers storage for any space!

DESCRIPTION	PARTS / CARTON	PART NO.	COLOR
UNIVERSAL DRAWER STORAGE TRAY	90	CPF-F12750P	BLACK

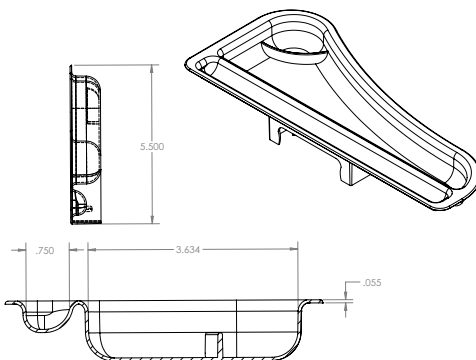
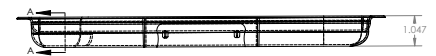
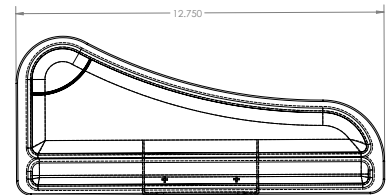



BELOW THE DESK STORAGE

Organization products designed to create smarter work environments



PENCIL AND NOTEBOOK DRAWERS

The compartments of the Pencil Drawers are ribbed to prevent items from sliding around and help to keep the drawers organized. The included ball bearing slide rails allow the units to smoothly open and shut with very little effort. The units are easy to install with the included hardware and are available in two convenient sizes.

WIDE PENCIL DRAWER

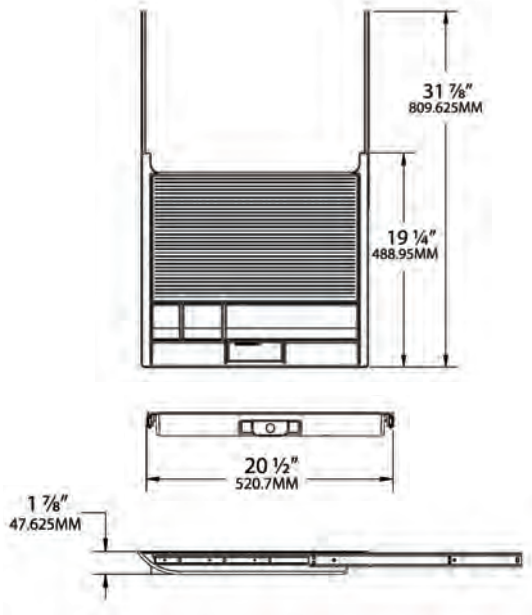

DESCRIPTION	PARTS / CARTON	PART NO.	COLOR
WIDE PENCIL DRAWER	10	CPF-89777	BLACK

NARROW PENCIL DRAWER

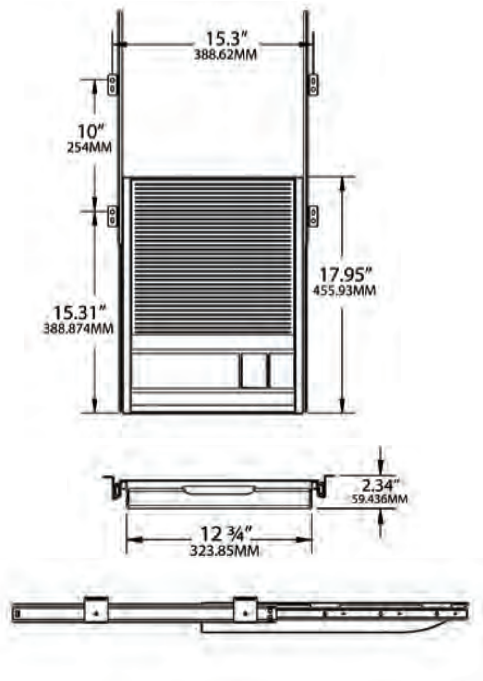

DESCRIPTION	PARTS / CARTON	PART NO.	COLOR
NARROW PENCIL DRAWER	10	CPF-89310	BLACK

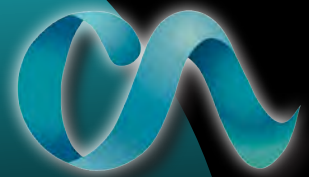

RADIUS ORGANIZER



This uniquely designed drawer can be installed almost anywhere. Simply push one end and the drawer rotates 180 degrees to allow access to commonly used items including pens, pencils, paper clips, and tape.

Includes one assembled organizer and installation hardware with instructions.

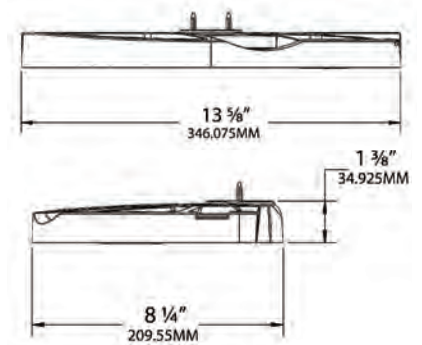

DESCRIPTION	PARTS / CARTON	PART NO.	COLOR
	16	CPF-SCI-WK451B	BLACK
RADIUS ORGANIZER TRAY	16	CPF-SCI-WK451C	CLEAR
	16	CPF-SCI-WK451S	SILVER

RADIUS ORGANIZER JR.



The compact Radius Organizer Jr. is best used for smaller spaces keeping supplies organized. The sleek design rotates and stops in open and closed positions concealing contents from view. Simply push one end and the drawer rotates 180 degrees to allow access to commonly used items.

Includes one assembled organizer, screws, and installation instructions.



DESCRIPTION	PARTS / CARTON	PART NO.	COLOR
	20	CPF-SCI-WK455B	BLACK
RADIUS ORGANIZER JR. TRAY	20	CPF-SCI-WK455S	SILVER

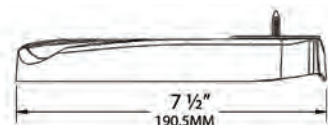



BELOW THE DESK STORAGE

Organization products designed to create smarter work environments



HANGING FILE RAIL

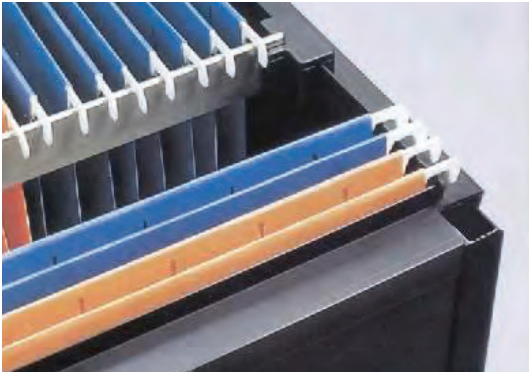

The Hanging File Rail is a simple H extrusion that fits securely on wood drawers and is easy to cut to desired lengths. Pendeflex files hang over the top to create a simple, yet highly effective drawer organization system.

The Hanging File Rail is available in three sizes and two color options.

DESCRIPTION	SIZE	PARTS / CARTON	PART NO.	COLOR
FILE RAIL, 2.5M	1/2"	100	CPF-32500	BLACK
		100	CPF-312501	WHITE
	5/8"	100	CPF-580FR	BLACK
		100	CPF-581FR	WHITE
	3/4"	100	CPF-32750	BLACK
		100	CPF-32750W	WHITE

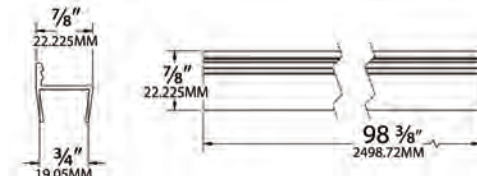
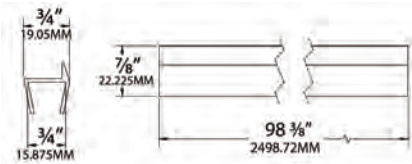
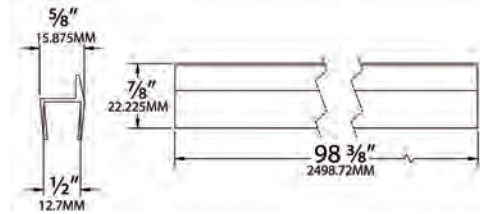

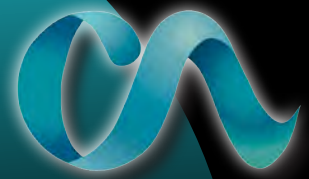

The File Rail Clip converts file drawers to accommodate letter size and legal size folders and is compatible with standard aluminum and steel bar stock. The File Rail Clip always stays in place and is easy to install.

FILE RAIL CLIP

Custom colors are available upon request.

DESCRIPTION	PARTS / CARTON	PART NO.	COLOR
FILE RAIL CLIP	3000	CPF-9000	BLACK
	1000	CPF-900K	BLACK

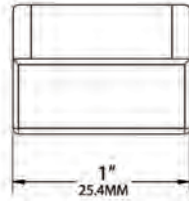
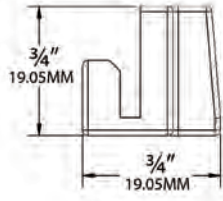
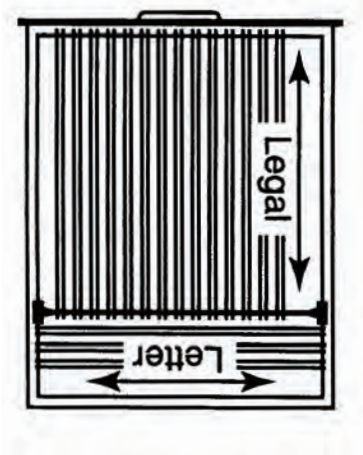

A clear acrylic desk organizer is mounted on a wall. It features several compartments. The leftmost compartment holds a camera and a pair of glasses. The middle compartment holds a pair of glasses. The rightmost compartment holds a pair of sunglasses. A smartphone is visible on the far right edge of the organizer. The background is a light blue wall with a white baseboard.

Maximize Organization

Desktop real estate is always at a premium. An open desk surface is ideal for impromptu meetings, reviewing blueprints, or just opening up the imagination for new product ideas. Custom Accents® offers flexible, easy to install work space paneling that houses a variety of compartments for office accessories. These hard-working products help keep office clutter under control.

Shown Here

The Crystal Series and Handi Tool Rail



ABOVE THE DESK STORAGE

Maximize desktop space with innovative hardware



ABOVE THE DESK STORAGE

Maximize desktop space with innovative hardware



THE CRYSTAL SERIES SLATWALL ACCESSORIES

The Crystal Series accessories are designed to mount directly onto slatwall, tool rails, or most aluminum toolbar panels with no extra clips or attachments needed. Manufactured by us in-house and made with a strong but crystal clear polycarbonate, the Crystal Series are beautiful accessories perfect for inside the home such as the home office and craft room and inside traditional office buildings as well.

They could also be used in the retail or store fixture environment. Beautiful accessories made in USA!

BASKET

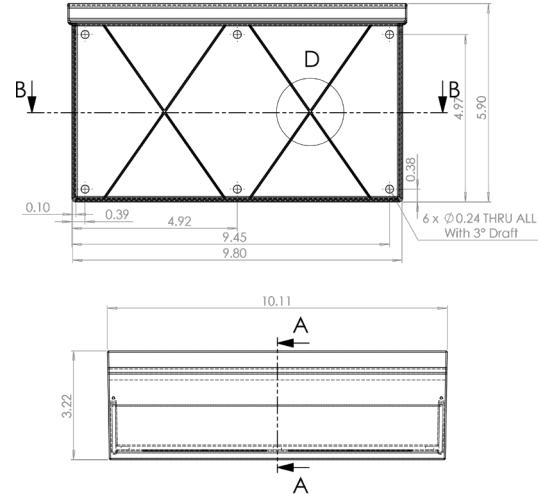

DESCRIPTION	PARTS / CARTON	PART NO.	COLOR
CRYSTAL SERIES, BASKET	6	CPF-HSCSBAS	CLEAR

ORGANIZER TRAY

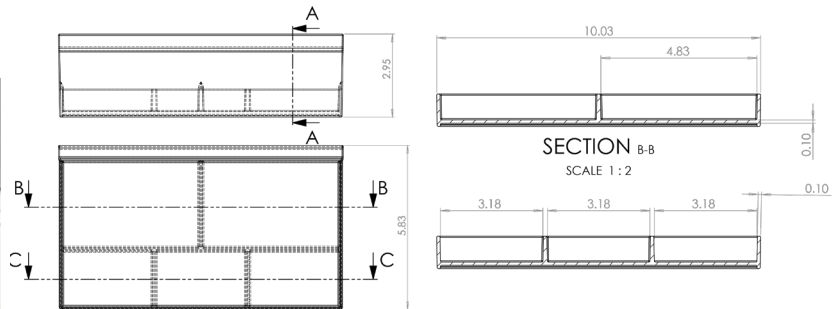

DESCRIPTION	PARTS / CARTON	PART NO.	COLOR
CRYSTAL SERIES, ORGANIZER TRAY	6	CPF-HSCSOT	CLEAR

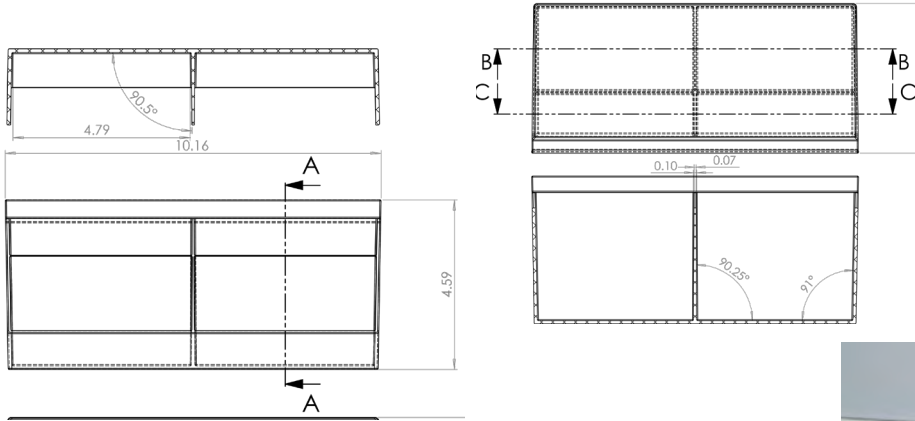
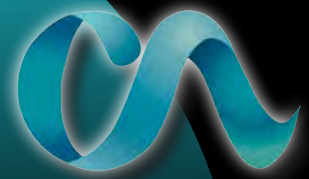

NIKNAK



DESCRIPTION	PARTS / CARTON	PART NO.	COLOR
CRYSTAL SERIES, NIKNAK	6	CPF-HSCSNIK	CLEAR

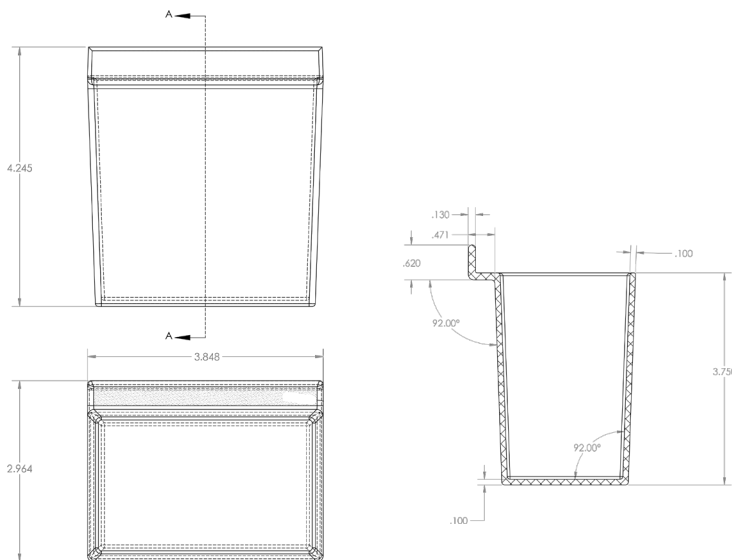

PENCIL CUP



DESCRIPTION	PARTS / CARTON	PART NO.	COLOR
CRYSTAL SERIES, PENCIL CUP	6	CPF-HSCSPC	CLEAR



ABOVE THE DESK STORAGE

Maximize desktop space with innovative hardware



HANDI TOOL RAIL

The Handi Tool Rail is a new product designed and manufactured by HandiSOLUTIONS® in a similar way to HandiWALL®. Made of the same cellular foam PVC material, the Handi Tool Rail provides all of the benefits of HandiWALL® while allowing a much smaller footprint to be used.

Perfect for the office or home office, as well as areas such as the entry way, storage rooms, mail rooms, closet, pantry, craft room, basement, mudroom, laundry room, and more! Each individual carton comes with the End Caps, color-matched screws, and Color Strips for installation.



DESCRIPTION	PARTS / CARTON	PART NO.	COLOR
HANDI TOOL RAIL, 50", WHITE	1	CPFTR150-IND	WHITE
HANDI TOOL RAIL, 82", WHITE	1	CPFTR182-IND	WHITE
HANDI TOOL RAIL, 50", GRAY	1	CPFTR350-IND	GRAY
HANDI TOOL RAIL, 82", GRAY	1	CPFTR382-IND	GRAY
HANDI TOOL RAIL, 50", BLACK	1	CPFTR450-IND	BLACK
HANDI TOOL RAIL, 82", BLACK	1	CPFTR482-IND	BLACK
HANDI TOOL RAIL, 50", BEACHWOOD	1	CPFTR1450-IND	BEACHWOOD
HANDI TOOL RAIL, 82", BEACHWOOD	1	CPFTR1482-IND	BEACHWOOD

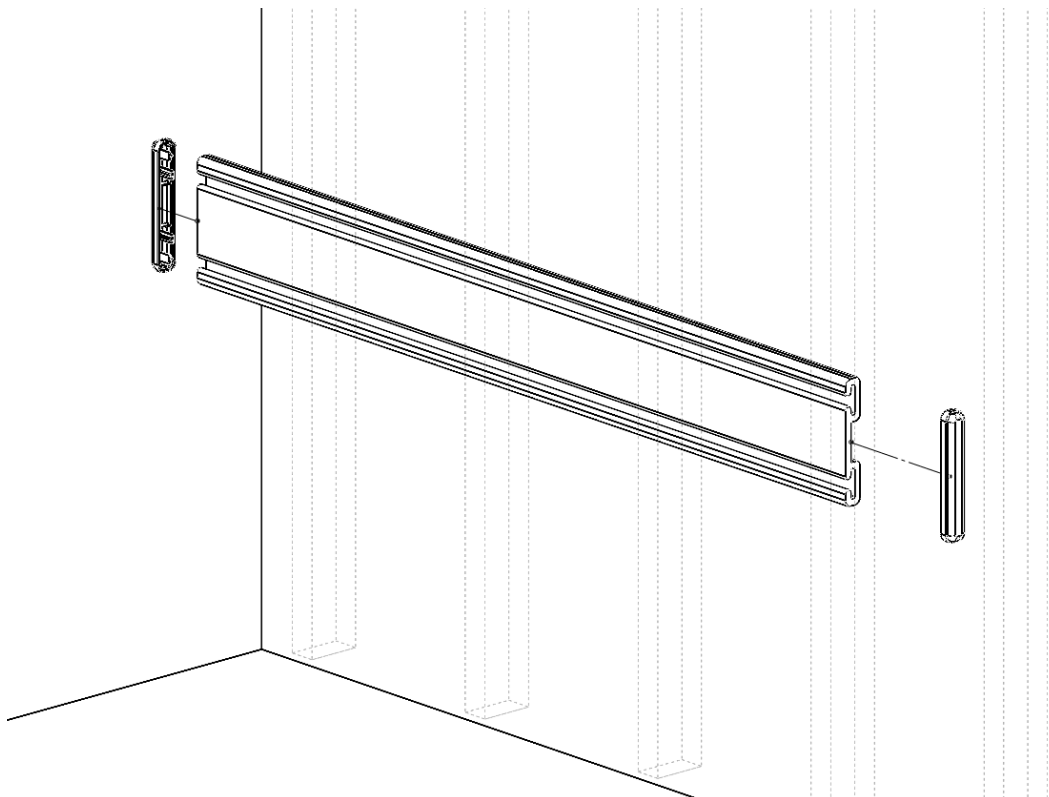
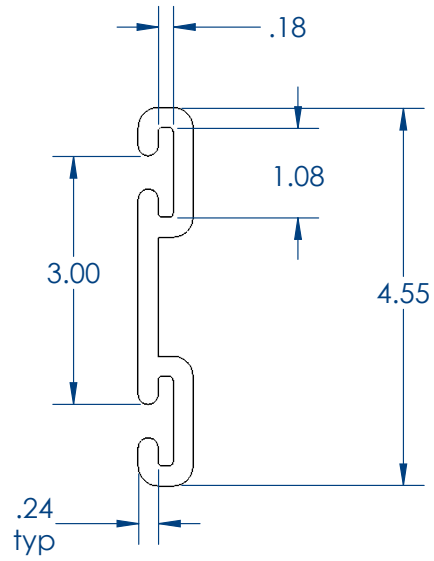
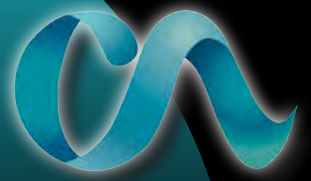



GLOSSARY OF PRODUCTS

50MM Wire Grommet	4
60MM Flexigrom	5
60MM Wire Grommet	4
80MM Flexigrom	5
80MM Wire Grommet	5
Bag Holder Attachment	25
Cable Snake	12
Cable Trough	13
Crystal Series Basket	42
Crystal Series Organizer Tray	42
Crystal Series NikNak	43
Crystal Series Pencil Cup	43
File Rail Clip	38
FIS 214 Folding Table Adapter	25
Folding Leg Mechanisms	27
Handi Tool Rail	44
Hanging File Rail	38
Height Adjustable Lounge Table	30
Large Paper Slot Grommet	7
Latch Duct Channel	14
Latch Duct Clip	14
Link 360™	10
Mini Wiremaster Channel	15
Module Connector Type "Divide"	21
Module Connector Type "Lock"	21
Narrow Pencil Drawer	35
n00k™ Drawer	34
Oval Grommet	6
Paper Slot Grommet	7
Pencil Tray	34
Performance Connector	21
Radius Organizer	36
Radius Organizer Jr.	36
Release Kit for Tip Top Tables	27
System Panel "Fix"	22
System Panel "Flex"	22
System SL Folding Leg Adapter	26
System Take Off Adapter	26
Table Connector Type "Divide"	20
Table Connector Type "Lock"	20
Table Connector Type "Steel"	20
Tip Top Folding Table Full Kit	44
Universal Drawer Storage Tray	35
Vertebra Wire Manager	30
Wave Cable Grip	16
Wide Pencil Drawer	35
Wiremaster J Channel	15
Wireway Channel	15

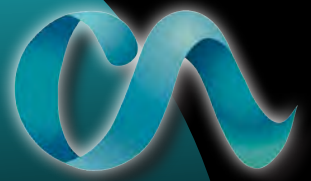

ORDERING INFORMATION

**MINIMUM ORDER**

As per OEM and Distributor Price Schedules.

FREIGHT

As per OEM and Distributor Price Schedules.

PAYMENT

Net 30 days with an approved account or by credit card.

ORDERS

All orders should include the Custom Accents part number, quantity, price, and have a purchase order. Full cartons sold only.

LEAD TIME

Product normally ships within 3 to 5 business days upon receipt of approved purchase order.

CONTACT US BY PHONE

Phone: 847-640-4725

CONTACT US BY EMAIL

info@customaccents.com

OUR LOCATION

Custom Accents
1940 Lunt Avenue
Elk Grove Village, IL 60007

FIND US ONLINE AT

www.customaccents.com

ONLINE STORE

store.customaccents.com

